

# Right Connections

towbar wiring kits for the uk

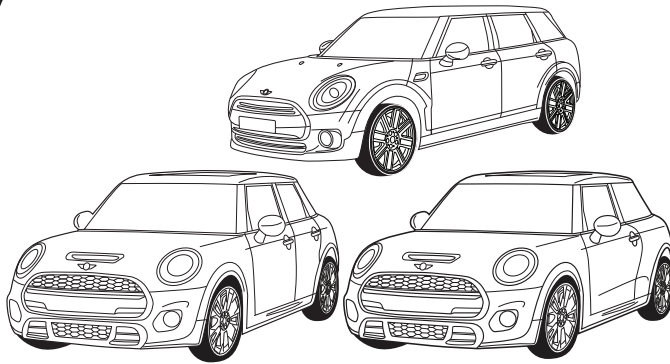

## MINI

<b>F54 Clubman</b>	<b>10/2015 &gt;&gt;</b>	<b>F60 Countryman</b>	<b>02/2017 &gt;&gt;</b>
<b>F55 5-doors</b>	<b>10/2014 &gt;&gt;</b>	<b>F60 Countryman PHEV</b>	<b>06/2017 &gt;&gt;</b>
<b>F56 3-doors</b>	<b>04/2014 &gt;&gt;</b>	<b>SE electric</b>	<b>03/2020 &gt;&gt;</b>
<b>F57 Convertible</b>	<b>03/2016 &gt;&gt;</b>		

**Part No: BW-027-13M**

## Electric wiring kit for towbars / 13-pin / 12 Volt / ISO 11446 Fitting instructions

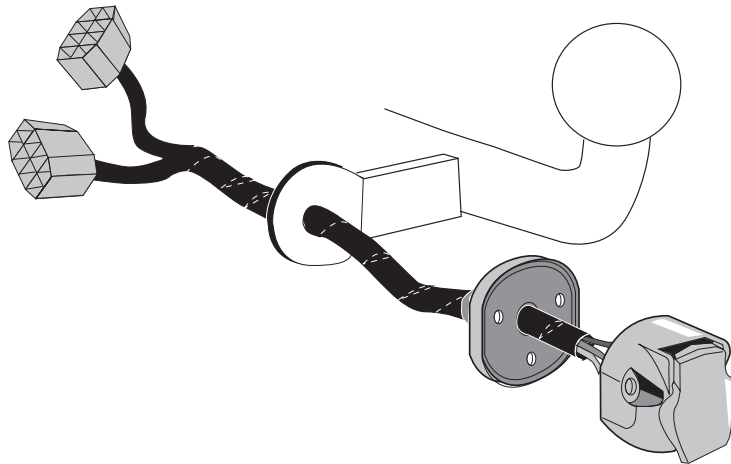

### IMPORTANT!

This electric kit has to be installed by a professional workshop or a suitable qualified person.

The installation instructions must have been read and fully understood before the start of any installation. Please contact your wiring kit provider or the hotline shown in the footer should you need assistance!

Make sure the vehicle is approved/homologated by the manufacturer to tow a trailer!

Also please check that there is a definite compatibility between this vehicle and the electric kit!

Following the installation of the electric kit, the fitting instructions should be kept together with the vehicle service document and vehicle handbook. The fitting instructions contain important information relating to the use and function of the towing kit as well as for any diagnostic or activation process, that might have to be repeated in the future (e.g. after the performance of a vehicle software update).

All warranty claims will be forfeited if the electric kit or components contained therein are used incorrectly or modified. If a towing socket adaptor has been used to connect to the trailer or bike rack, this must be removed from the trailer socket once the trailer or bike rack has been disconnected.

If the trailer or bike rack is not equipped with a rear fog lamp, depending on the towing vehicle type, the correct function of the towing kit cannot be guaranteed. In such cases, a rear fog lamp should be retro fitted.

This towing electric kit will not be covered under warranty if any technical or electrical modifications or software updates have been performed by the vehicle manufacturer after the initial commissioning of the kit. That applies especially to modifications or updates which may cause malfunctions in the trailer socket or any other part of the trailer electrical equipment!

Depending on the type of trailer module used in this electric kit, diagnostic interrogation with the vehicle's electrical system may be limited or will not function. The error memory inside the trailer module may not be able to be accessed by vehicle manufacturers diagnostic system.

Error logs relating to the trailer electrical equipment, that may be generated in the vehicle manufacturers diagnostic system as a result of a test procedure, may be due to the incorrect installation of the towing electric kit or the false activation of the trailer module.

**We always recommend whenever possible, the following troubleshooting process:**

- An analysis of the vehicle's error memory and possibly clearing of all faults before the start of the installation!
- Try disconnecting the trailer module from the towing harness and re-start the fault clearing process!
- If in doubt, limit the time for troubleshooting to a max of 0,5 hours and call our Technical Support Team!

Please follow our instructions carefully and always test the towing electrics using a true lighting board or a specifically designed bulb tester. If an LED tester is used, ensure it is equipped with correct load resistors or malfunctions will occur!

This instruction is subject to changes and we reserve the right to make changes to design, colour etc.

All of the data and illustrations may not be an exact representation but the text contained in this instruction must be observed!

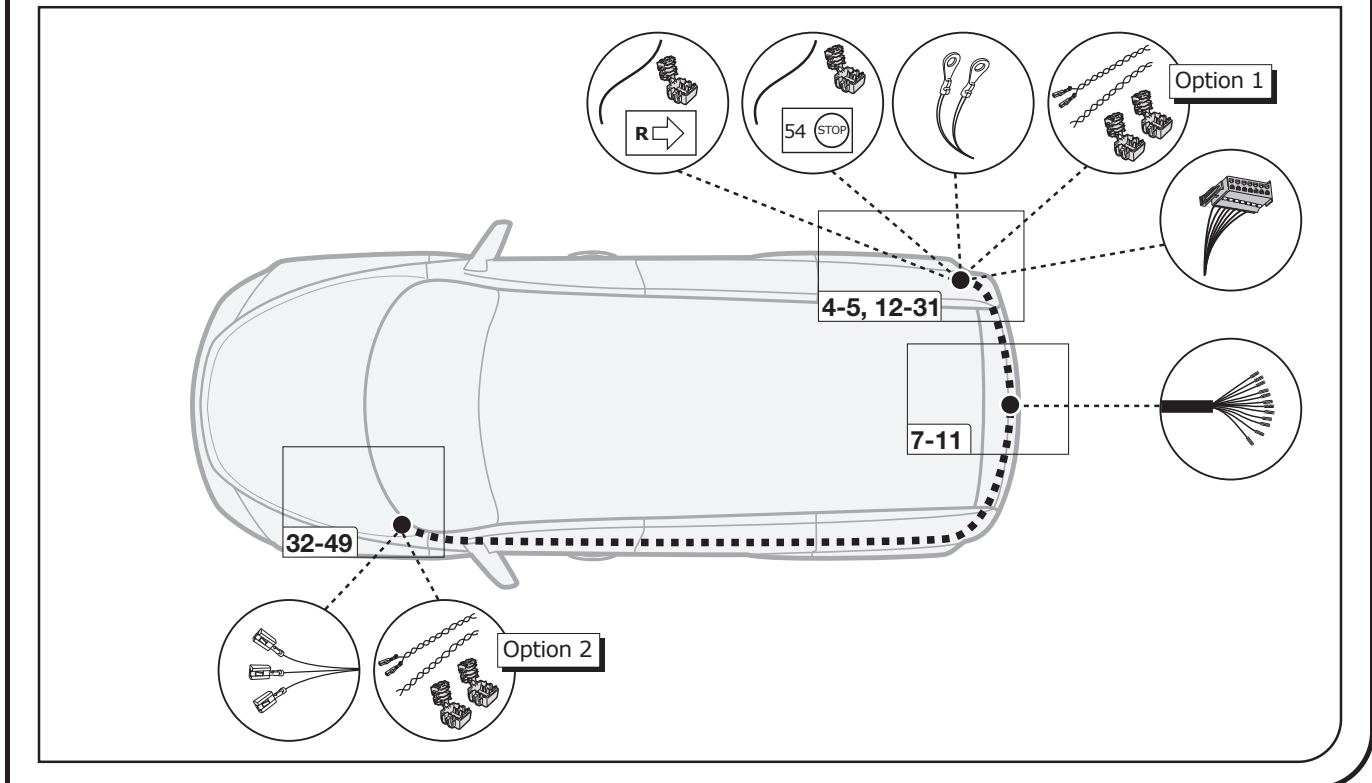
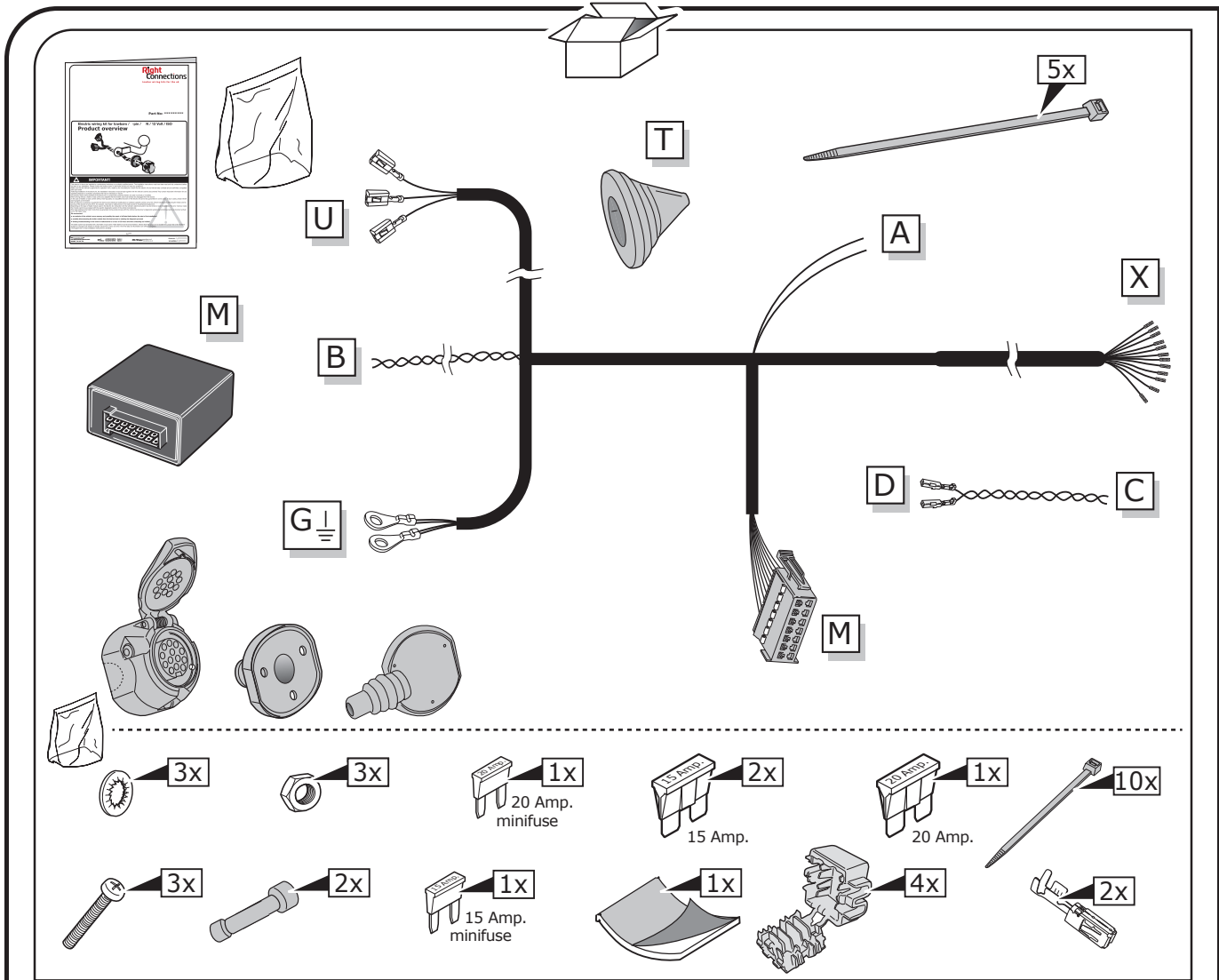

## SYMBOL EXPLANATION

	Left (58-L) respectively Right (58-R) tail light		Cigarette lighter / accessory socket
54	Stop light (54) / high mounted, third stop light (54)		Loudspeaker / buzzer
	Turn signal indicator left		Park Distance Control
	Turn signal indicator right		Switch / source of function
	Rear fog light(s)		Connect together
	Reversing light(s)		Disconnect
	Permanent power supply / 13pin socket, chamber 9		Look at / See further information
	Charging wire for trailer battery / 13pin socket, chamber 10		Look carefully at selected area
	Trailer / trailer recognition		Present / Occupied / OK
<b>B+ / 30</b>	Permanent current power supply		Not present / Not occupied / Not OK
	Ground or Earth (31)		Acoustic indication
	Ground connection battery terminal lug		Attention / important advice
	Positive connection battery terminal lug		Fuse / fuse capacity 20 Ampère

## TOOLS

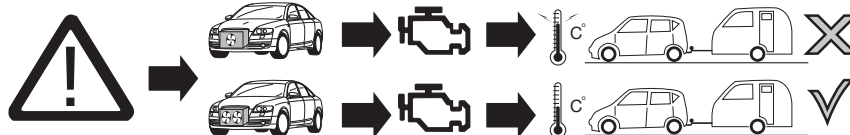
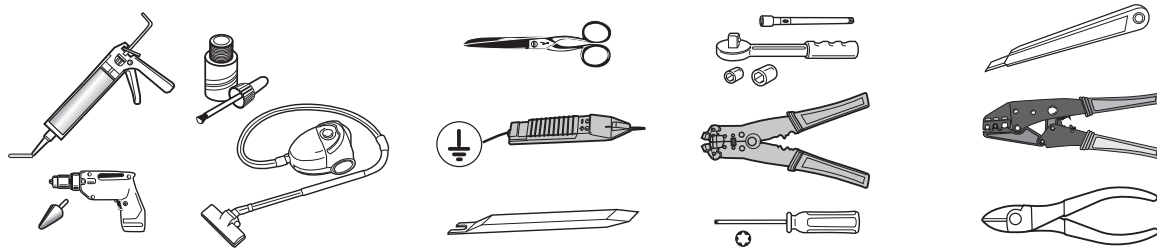

### ATTENTION!

The vehicle's cooling capacity may have to be increased when retrofitting a trailer coupling!  
You must observe the manufacturer's instructions!!

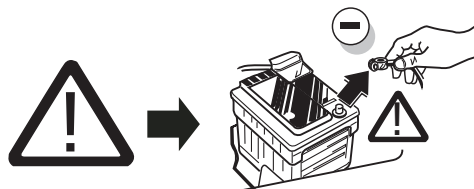

Note: It may be necessary to check if this vehicle has a stored radio code before disconnecting the battery!



### ATTENTION!

In order to avoid mal-functions and damage to the vehicle's electrical system the earth terminal **must be disconnected** from the vehicle's battery **before starting work!**

Both the trailer module and the vehicle's control unit for the electrical system can be damaged during work on the data bus connections if the battery is not disconnected!

1

Please pay attention to the manufacturer's instructions when disconnecting and reconnecting the vehicle's battery!

MINI

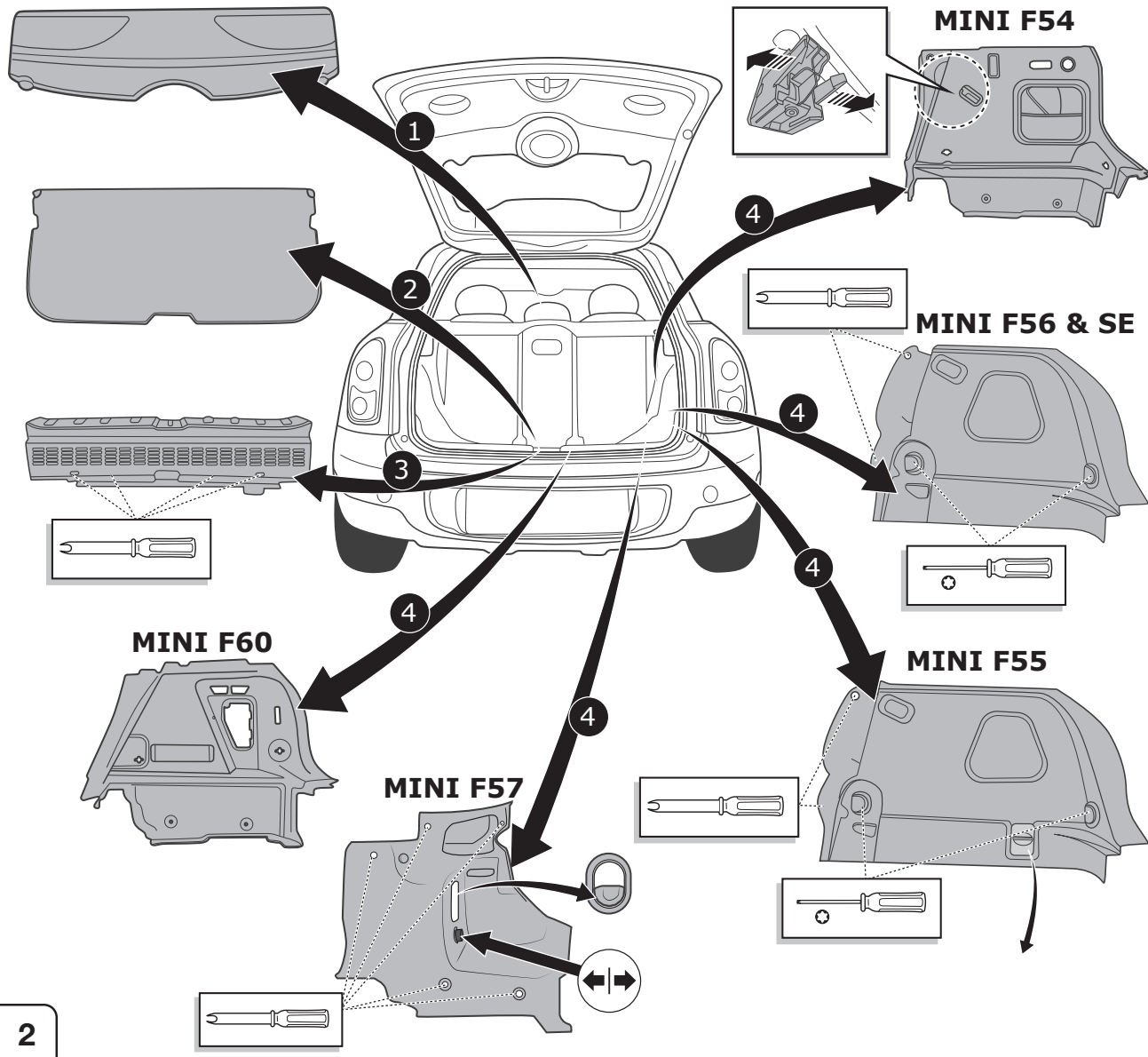

MINI

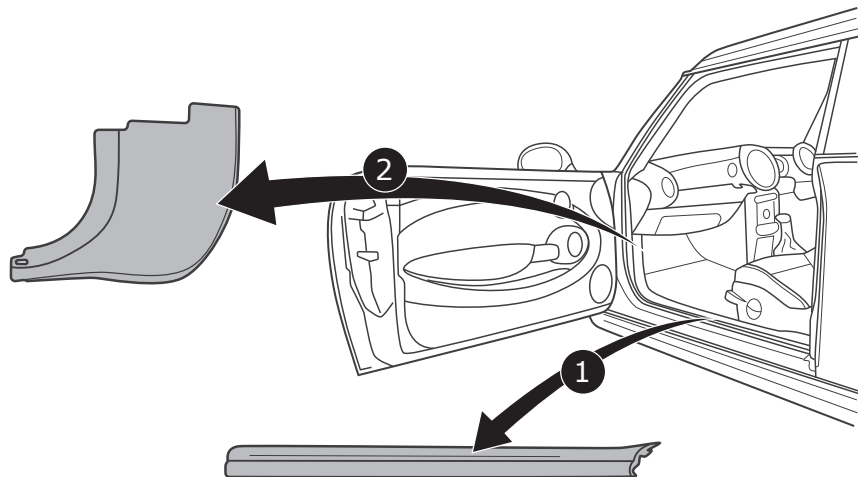

# MINI F54/ F57/ F60

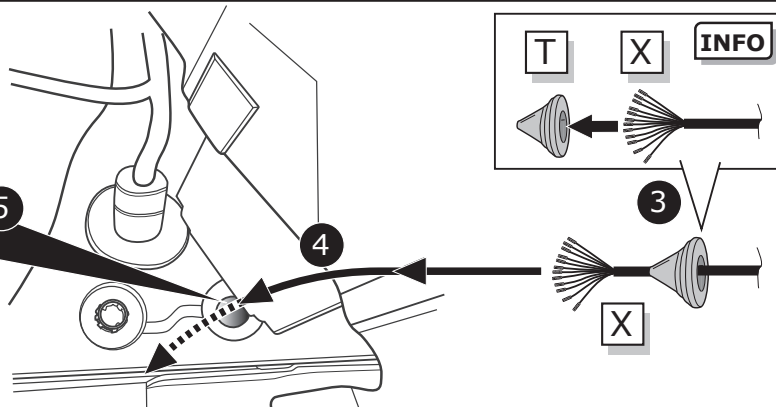
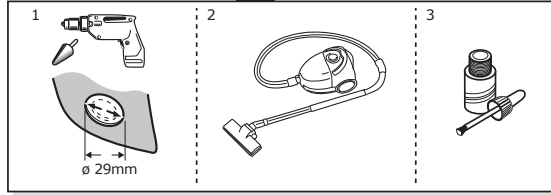
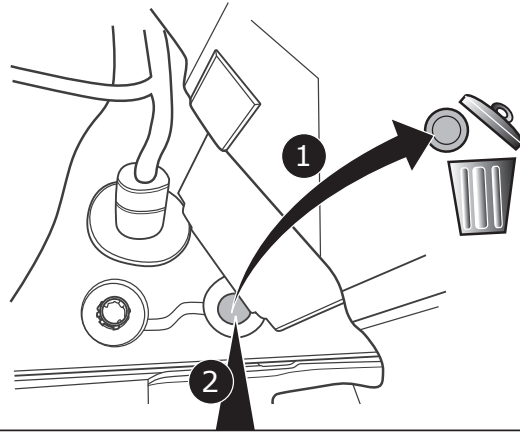
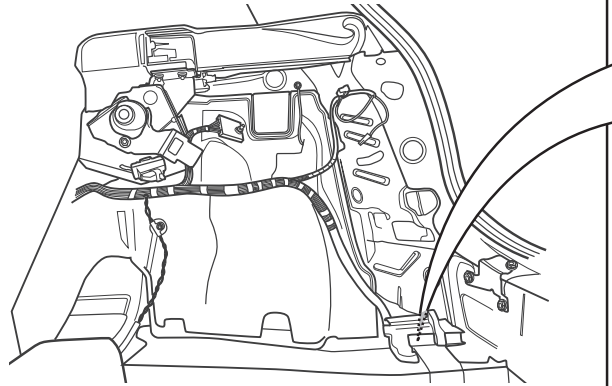

4

# MINI F55 / F56 / SE

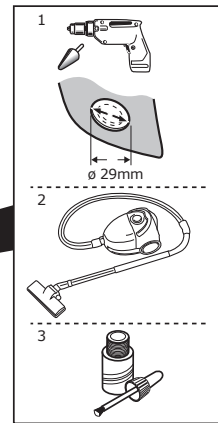
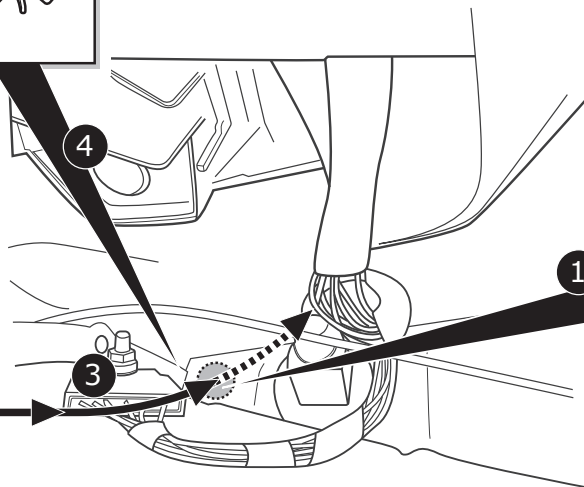
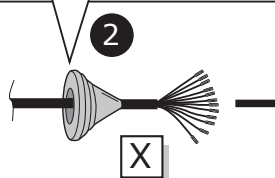
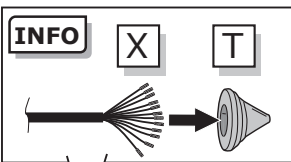

5

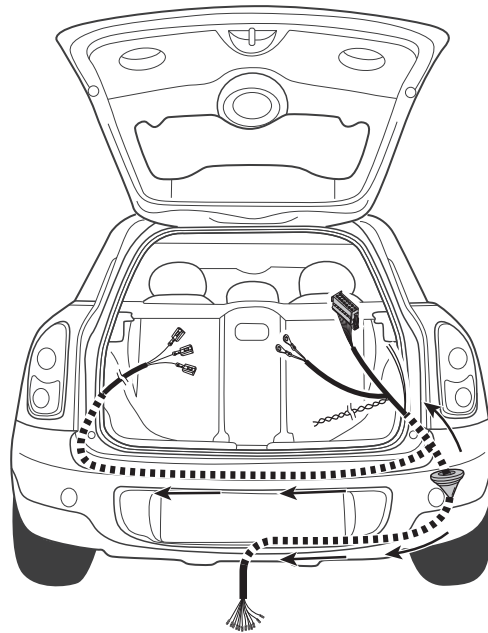

6

Option 1

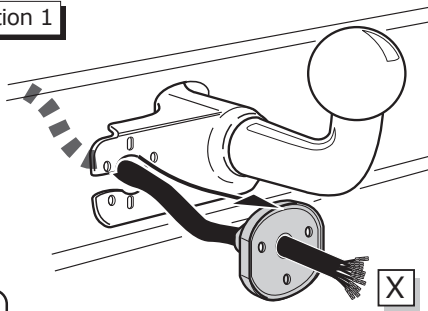

7

Option 2

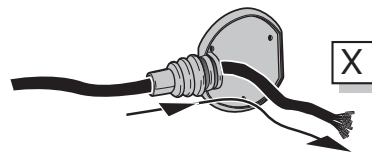

Option 3

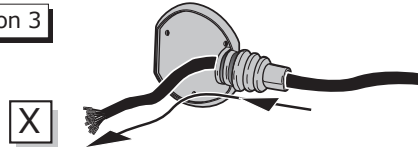

### SOCKET CONNECTION

DIN/ISO 11446	← L	⊕	⊖ 1-8	R →	☀	STOP	☀	Reverse	30+	15+	⊖ 10	—	⊖ 9
	1/L	2	3/31	4/R	5/58-R	6/54	7/58-L	8	9	10	11	12	13
Pmax	21W	21W		21W	42W	3x21W	42W	21W	180W	180W			
Colour	Yellow	Blue	White	Green	Brown	Red	Black	Pink	Orange	Grey	White/ Black	-	White/ Red

8

Option 1

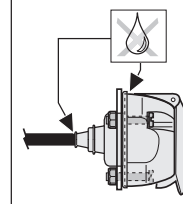
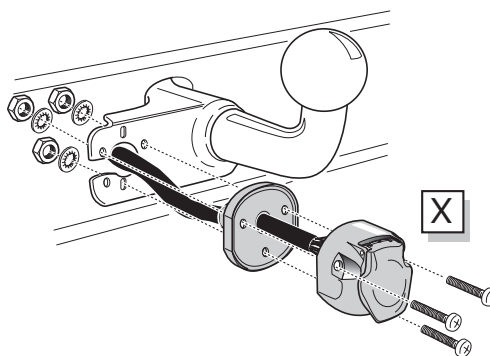

9



Option 2

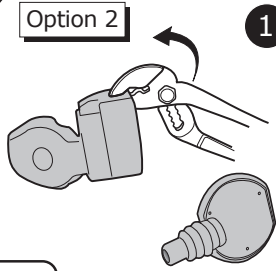

1

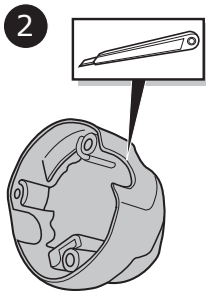

2

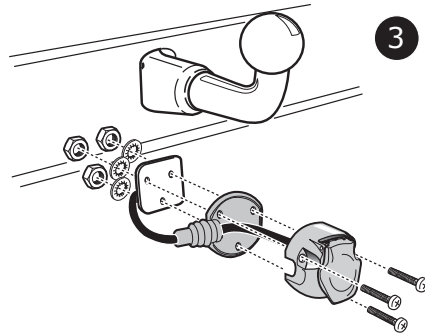

3

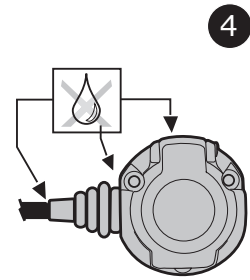

4

10

Option 3

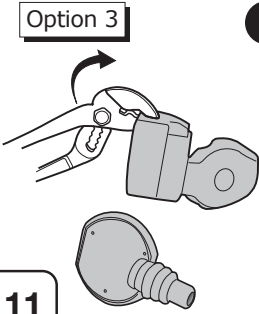

1

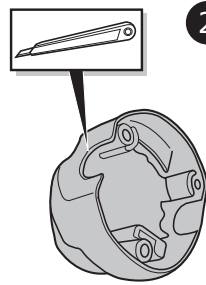

2

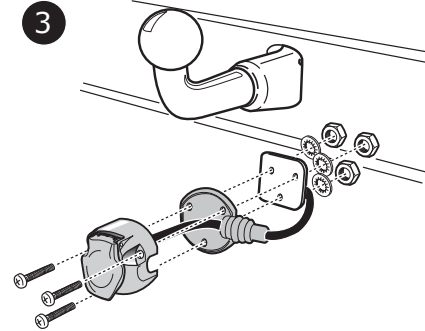

3

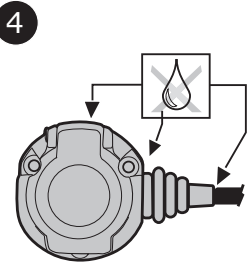

4

11

MINI F54/ F60

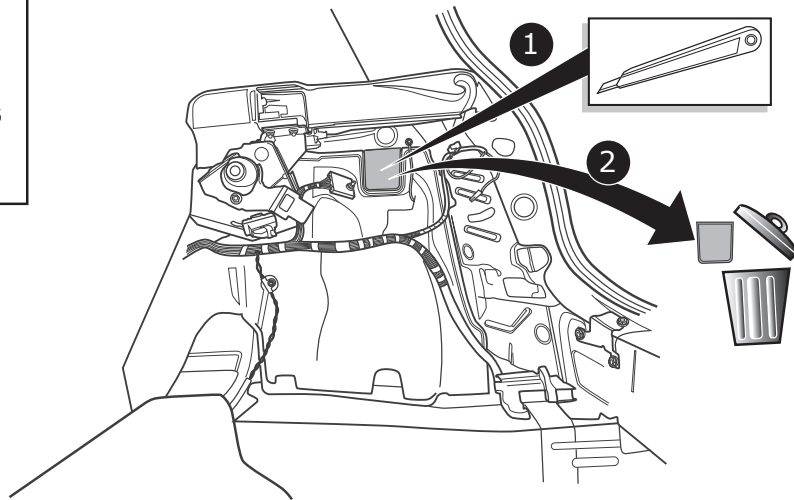
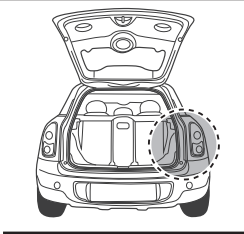

1

2

12

MINI

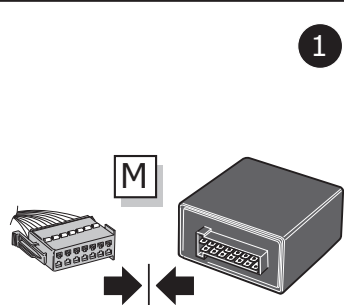

1

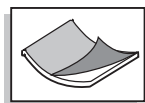

2

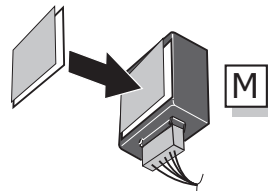

3

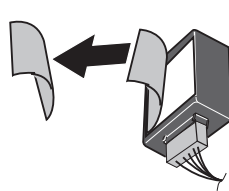

4

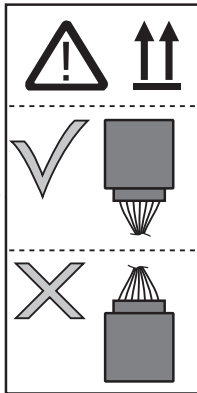

13

MINI F54/ F60



**!** Important!  
Please note informations in picture 1!

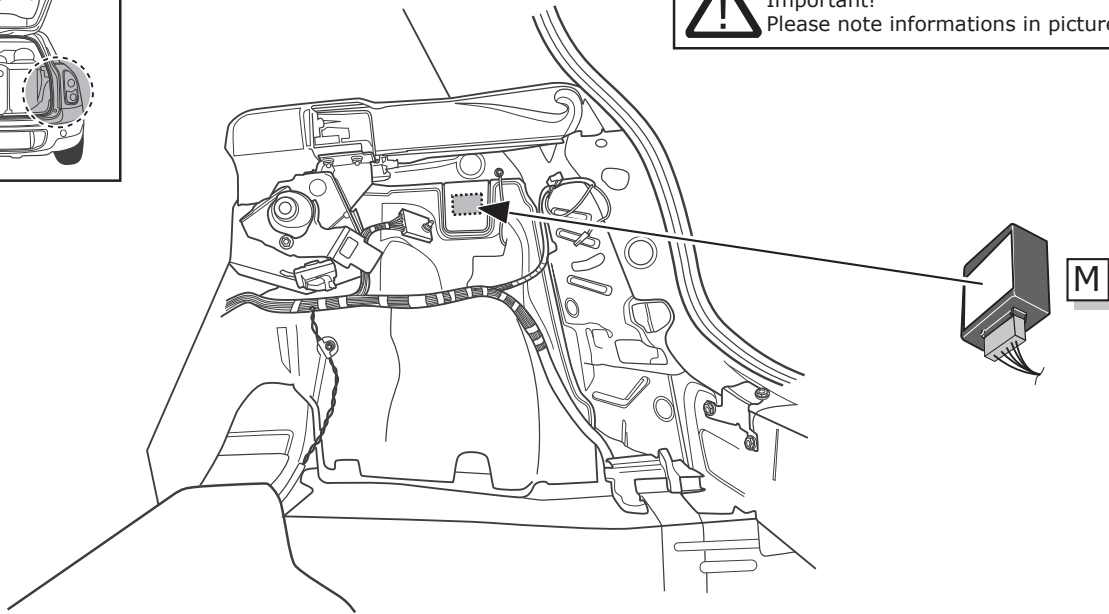

14

MINI F54/ F60

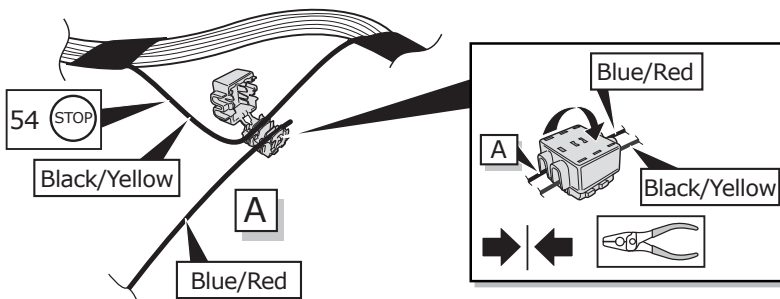
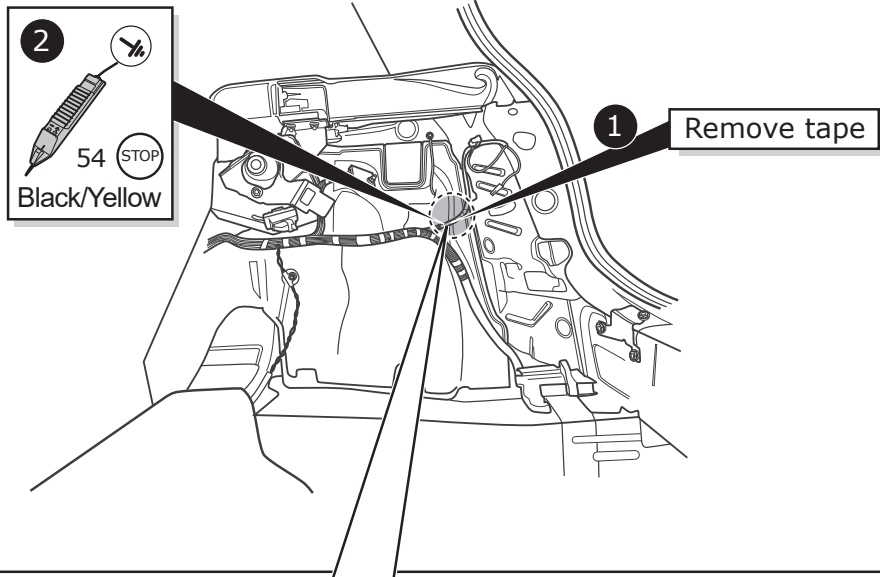

15



MINI F54/ F60

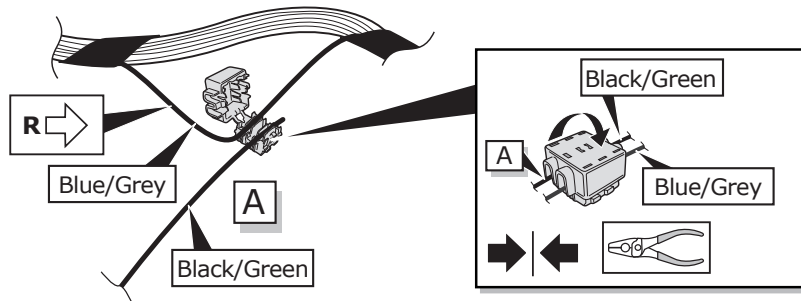
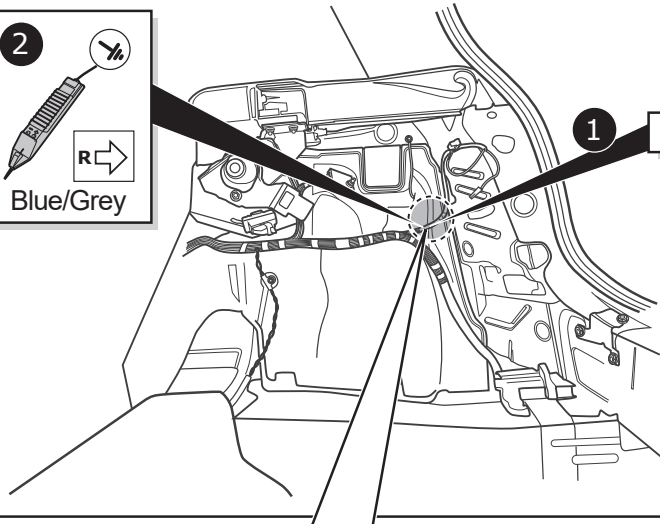
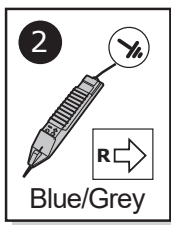

16

MINI F54/ F60

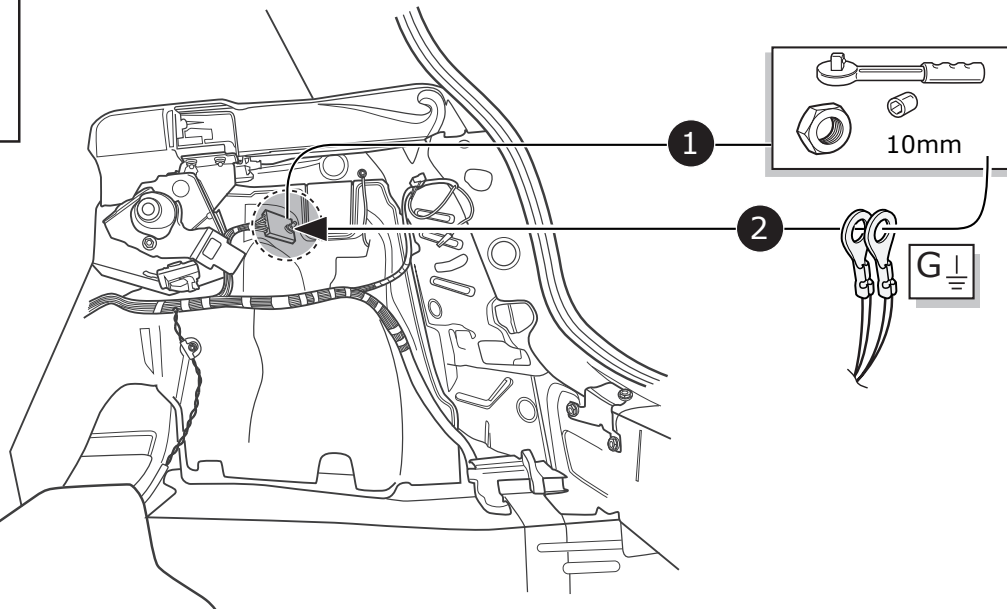

17

MINI F55/ F56/ F57 / SE



Important!  
Please note informations in picture 1!

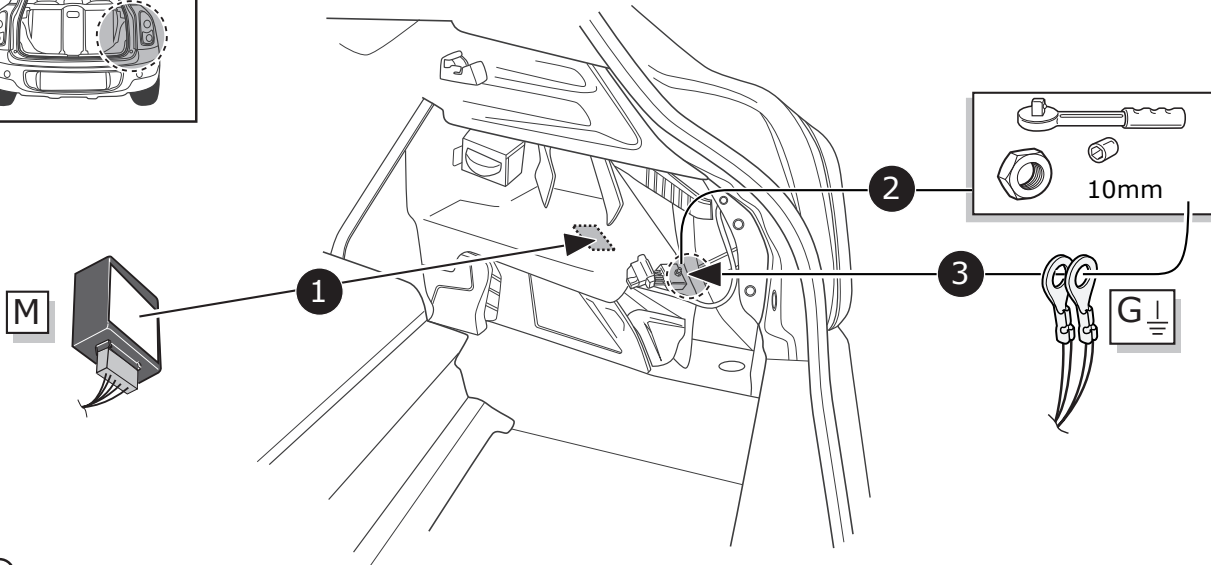

18

MINI F55/ F56 / SE

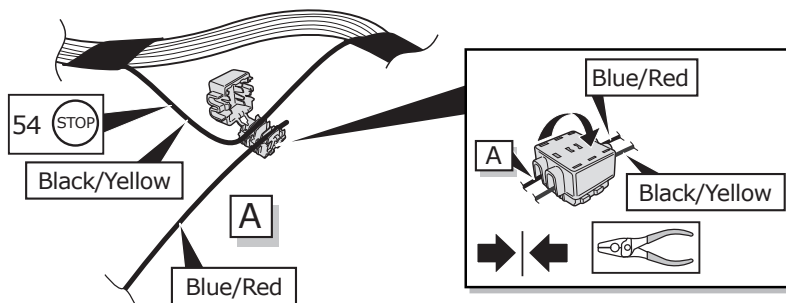
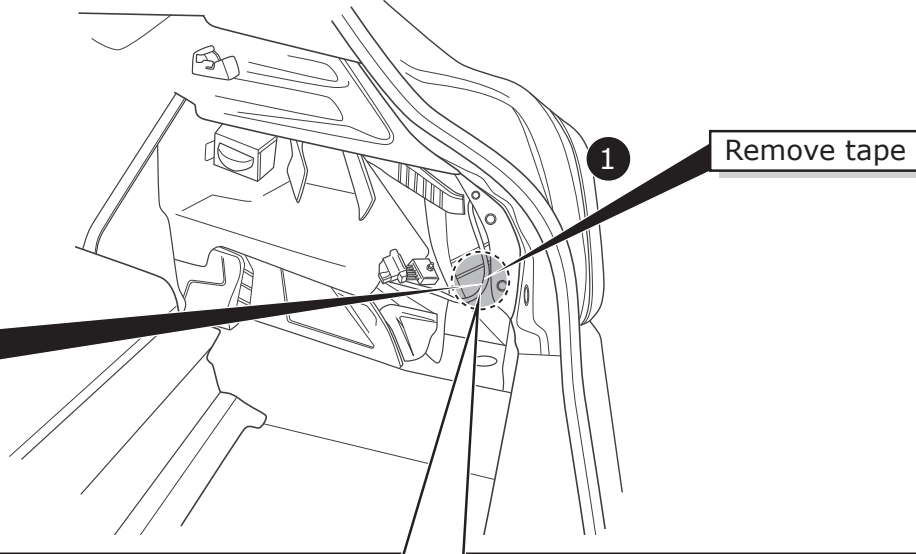
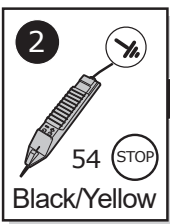

19

MINI F55 / F56 / SE

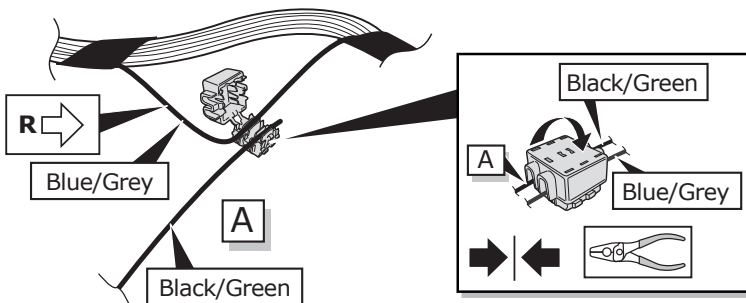
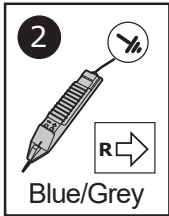
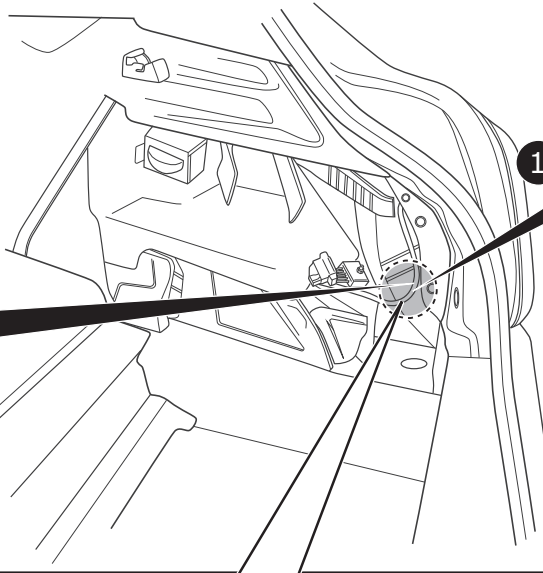

20

MINI F57

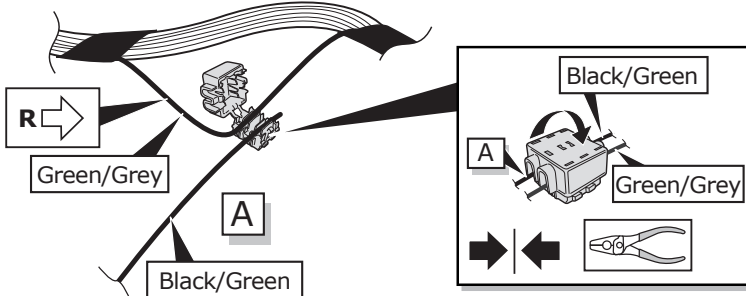
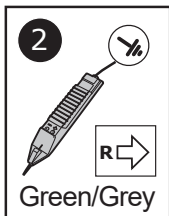
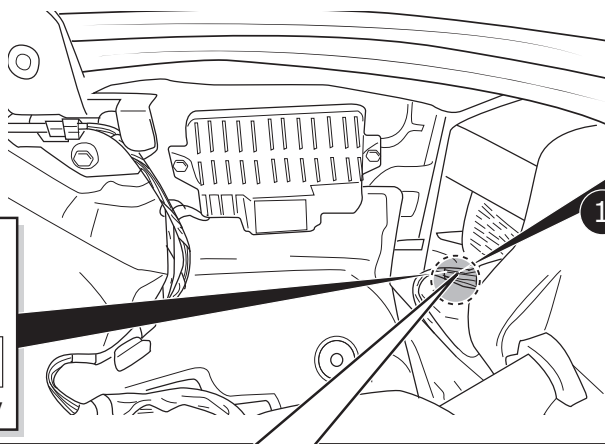

21

MINI F57

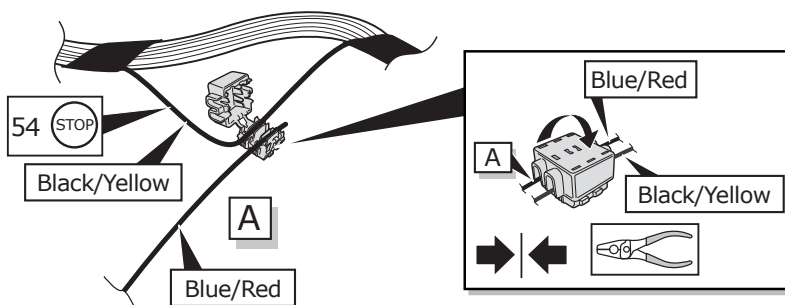
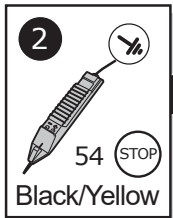
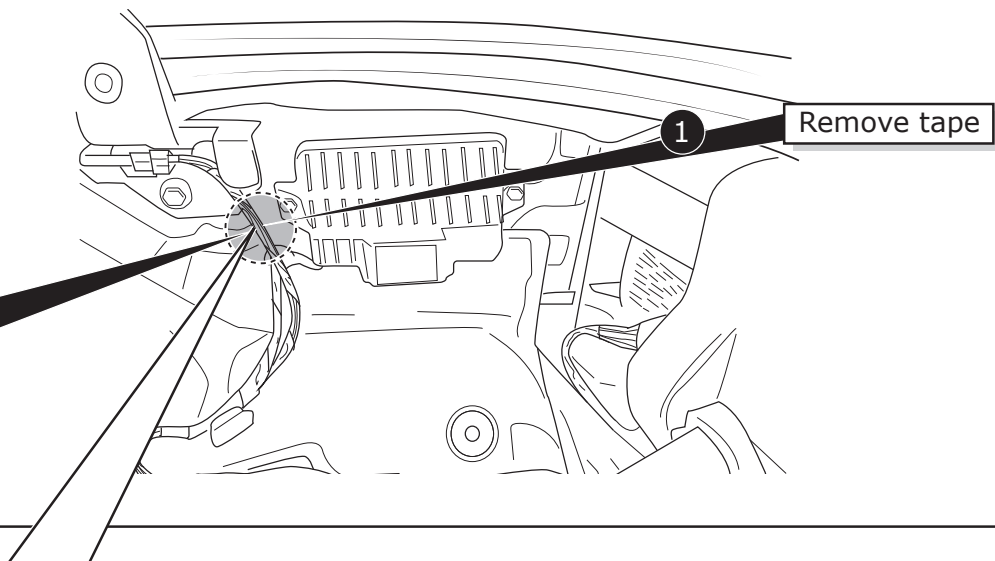

3

22

MINI F54 / F60

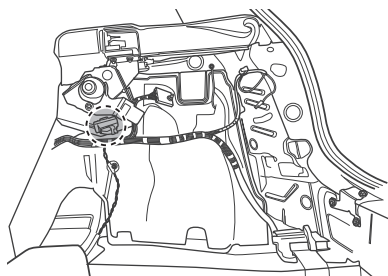

MINI F55 / F56 / F57 / SE

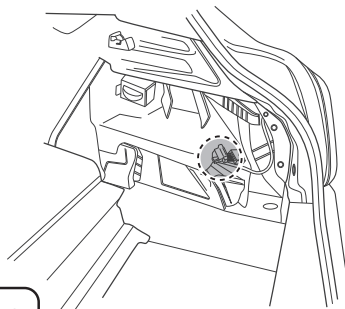

CAN-Data Wire

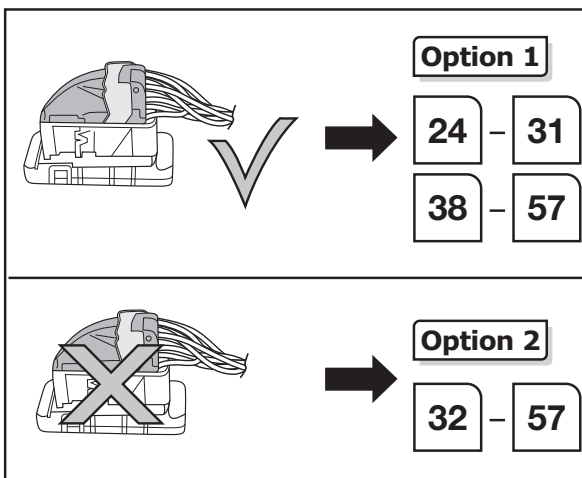
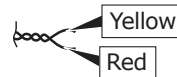

Important!  
Please note informations in picture 1!

23

**Option 1**

Cut to length!

Black

Yellow

**B**

24

**Option 1a**

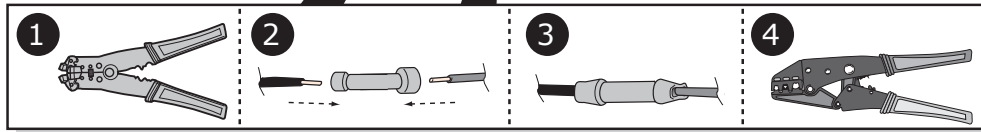
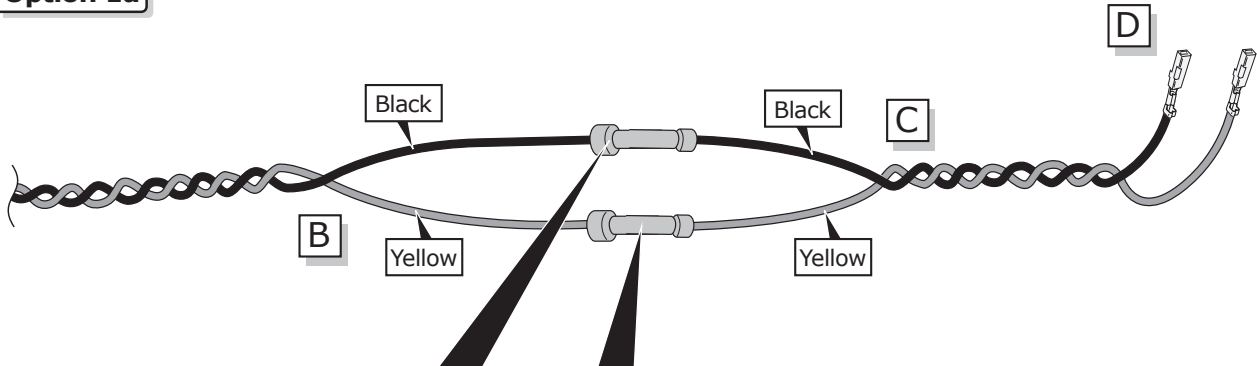

25

**Option 1a**

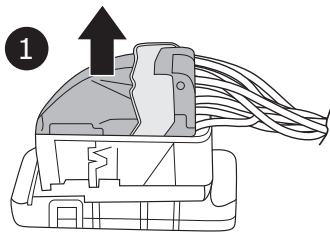

**CAN-Data Wire**

Yellow  
Red

**Important!**  
Please note informations in picture 1!

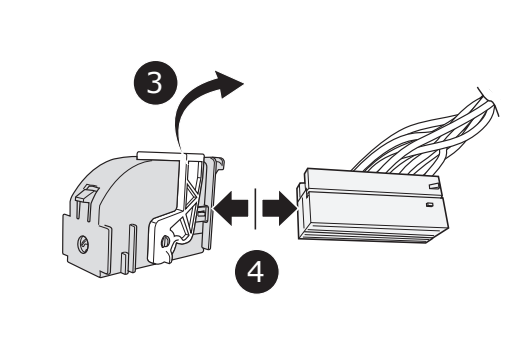
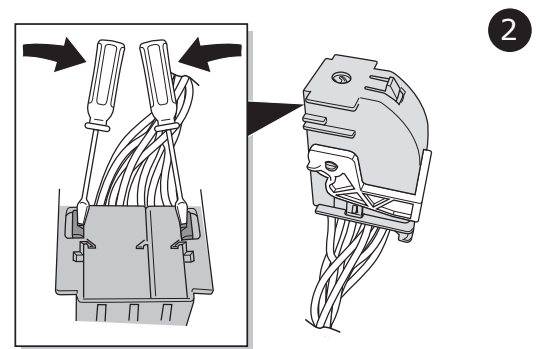

26

Option 1a

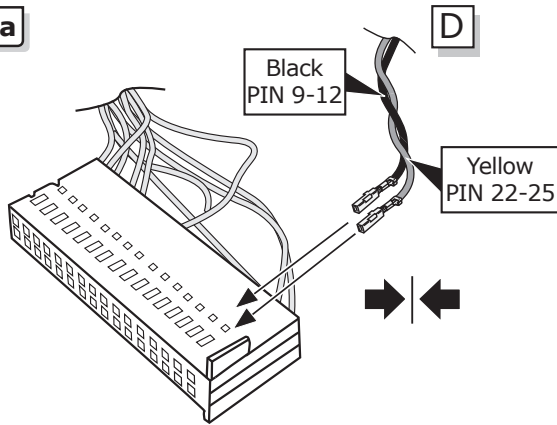

CAN-Data Wire

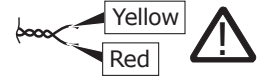

Important!  
Please note informations in picture 1!

27

Option 1a

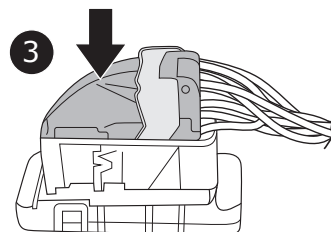
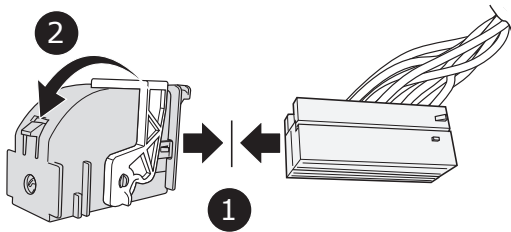

28

Option 1b

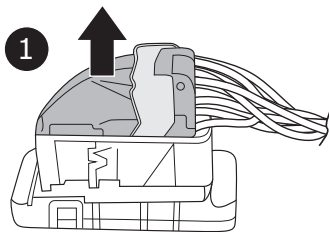

CAN-Data Wire



Important!  
Please note informations in picture 1!

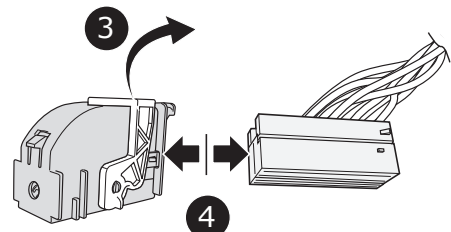
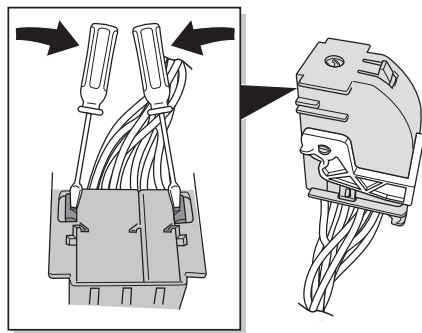

29



**Option 1b**

 Important!  
Please note informations in picture 1!

**CAN-Data Wire**

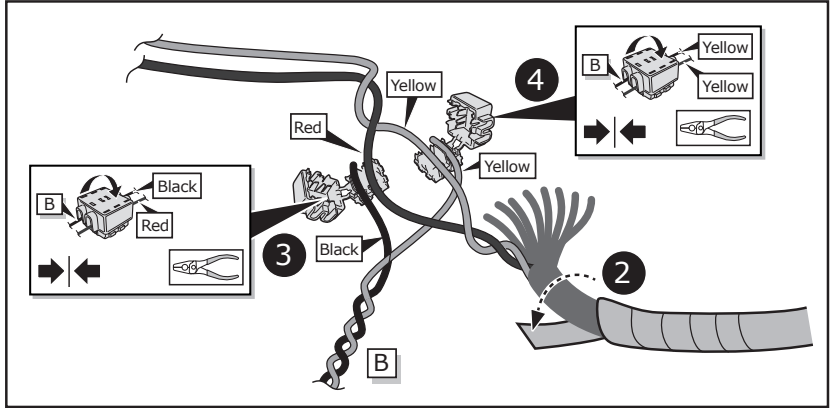
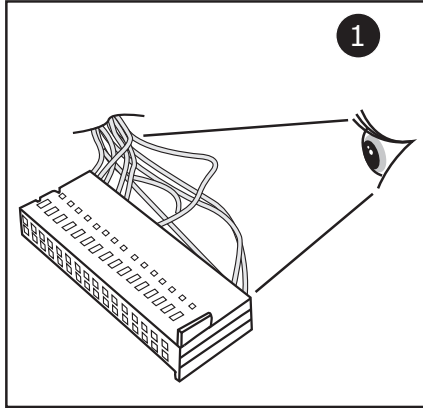

30

**Option 1b**

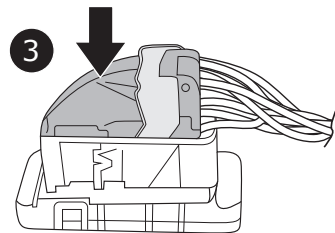
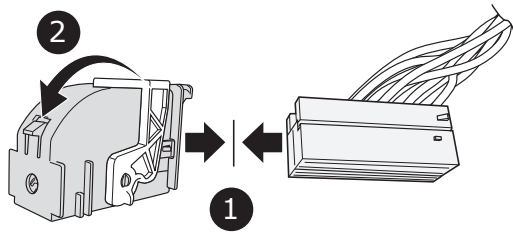

31

**Option 2**

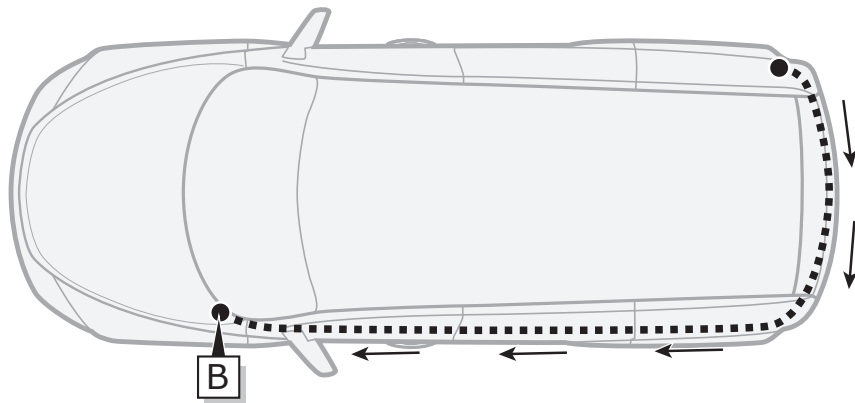

32

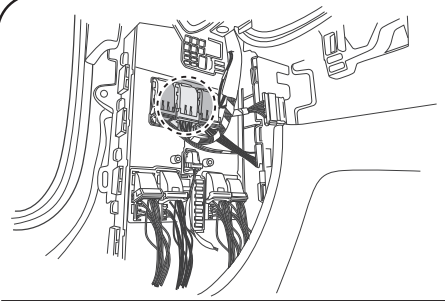

**Option 2**

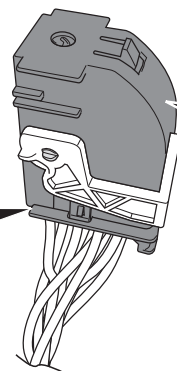
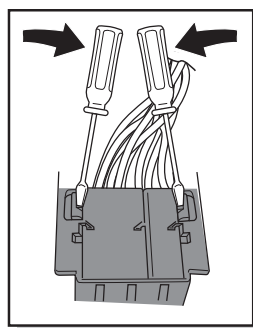

**Black 54-pin**

**1**

**CAN-Data Wire**

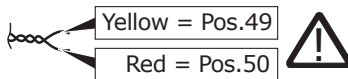

**Important!**  
Please note informations in picture 1!

**33**

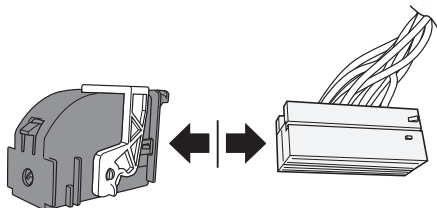

**2**

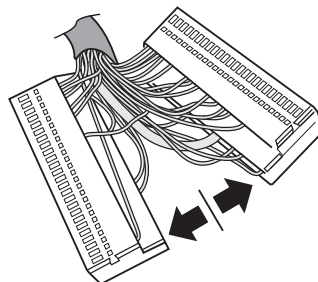

**3**

**Option 2a**

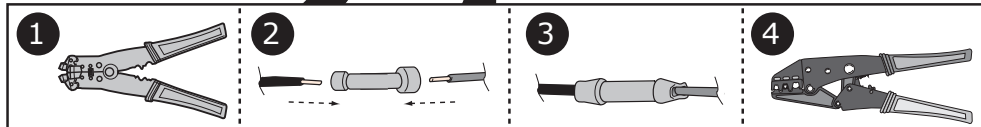
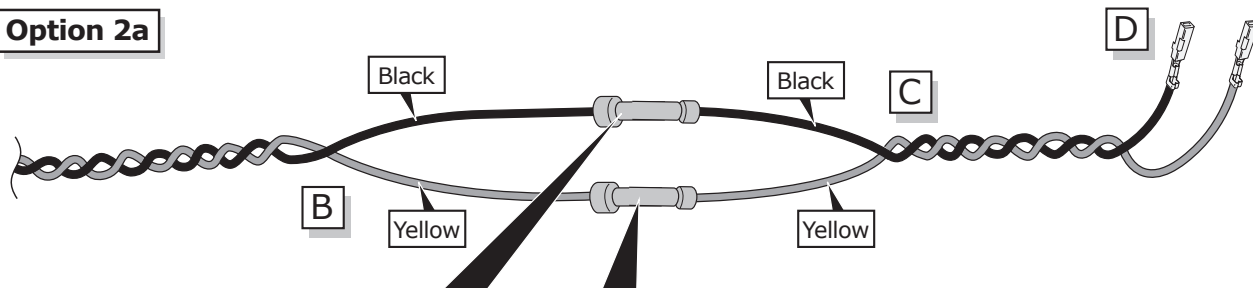

**34**

**Option 2a**

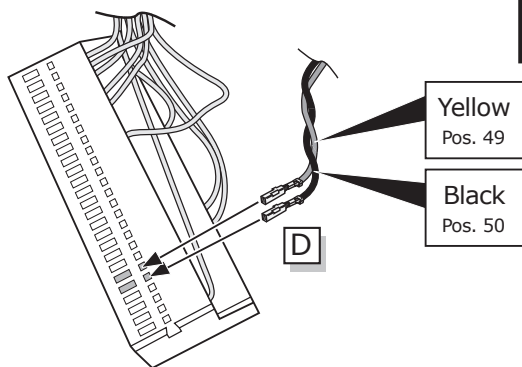

**Important!**  
Please note informations in picture 1!

**35**

**Option 2a**

36

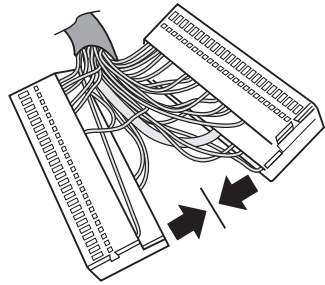

1

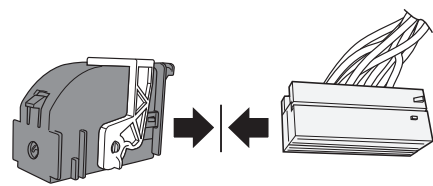

2

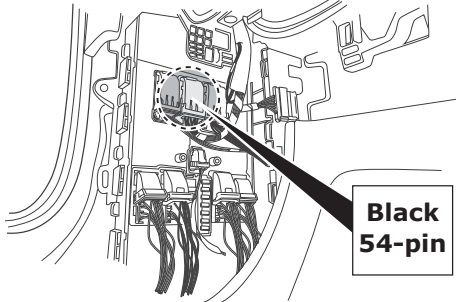

**Black 54-pin**

**Option 2b**

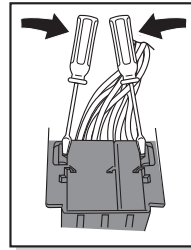

1

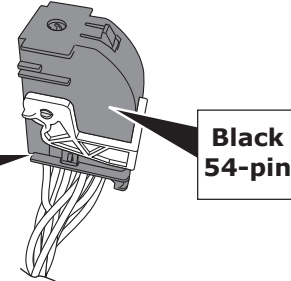

**Black 54-pin**

**CAN-Data Wire**

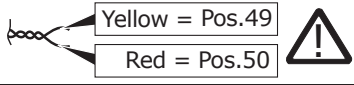

**Important!**  
Please note informations  
in picture 1!

37

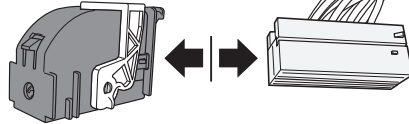

3

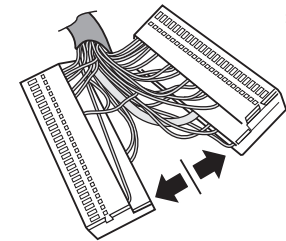

3

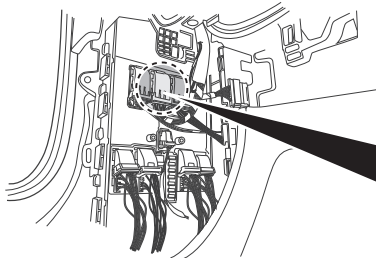

**Black 54-pin**

**Option 2b**

**Important!**  
Please note informations  
in picture 1!

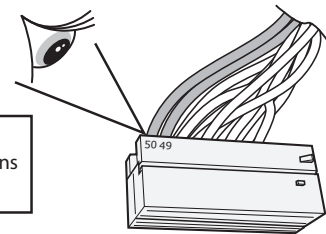

1

**CAN-Data Wire**

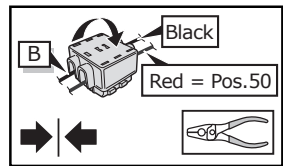
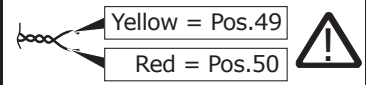

3

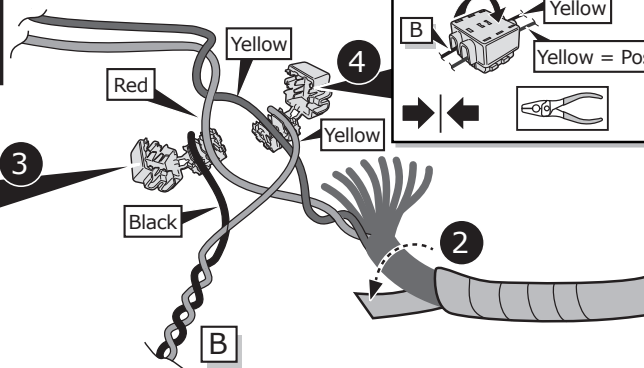

2

4

38

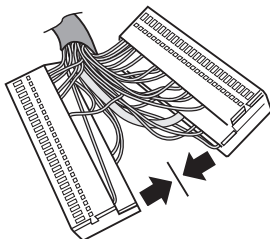

5

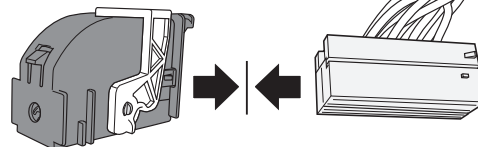

6

39

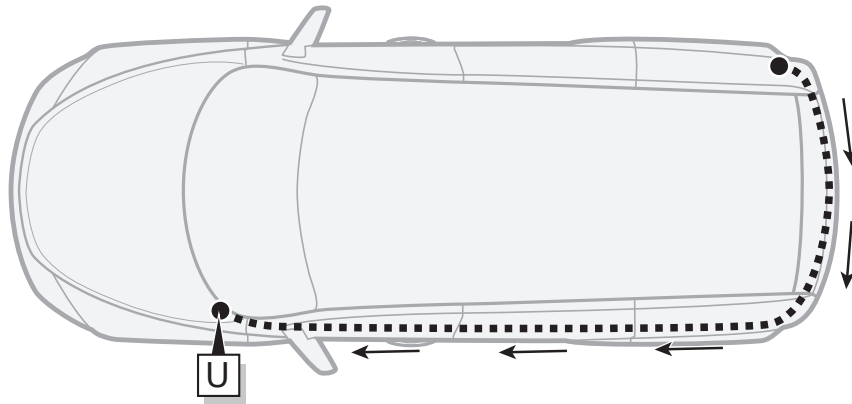

40

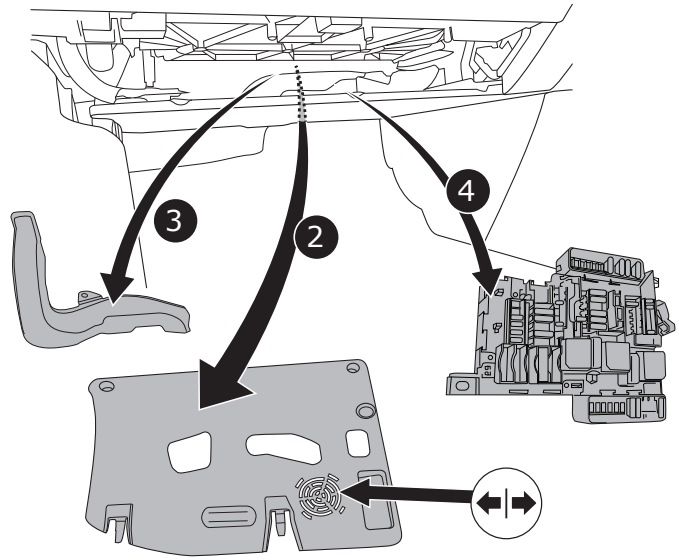
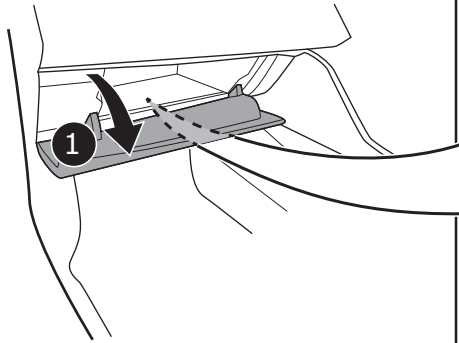

Option 1

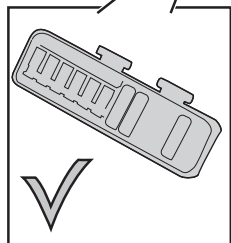
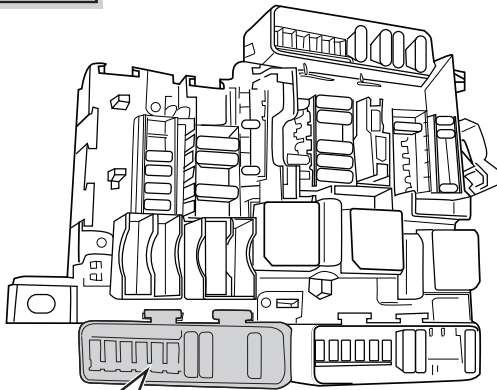

42 - 43  
49 - 57

Option 2

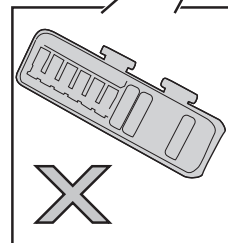
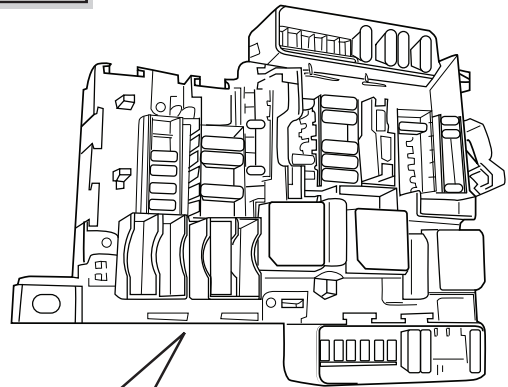

44 - 57

41



**Option 1**

1

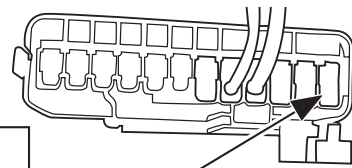
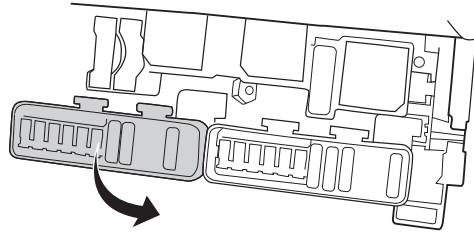

2

**Red/Blue**  
Choose a free space  
Chamber 103-108

U

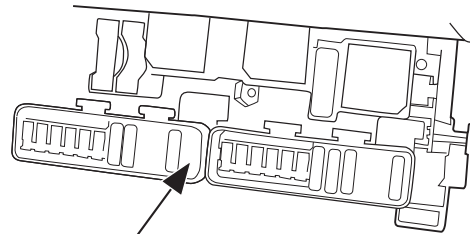
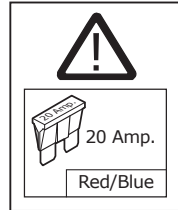
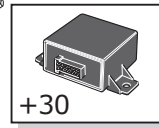

3

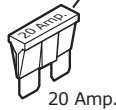

42



**Option 1**

1

**Optional chamber 9**

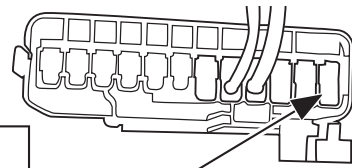
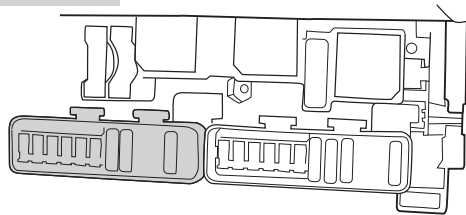

2

**Orange**  
Choose a free space  
Chamber 103-108

U

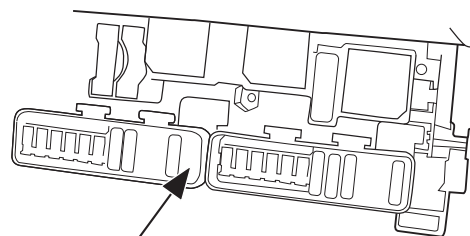
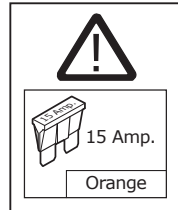
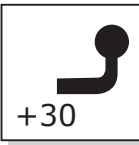

3

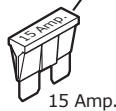

43



**Option 2**

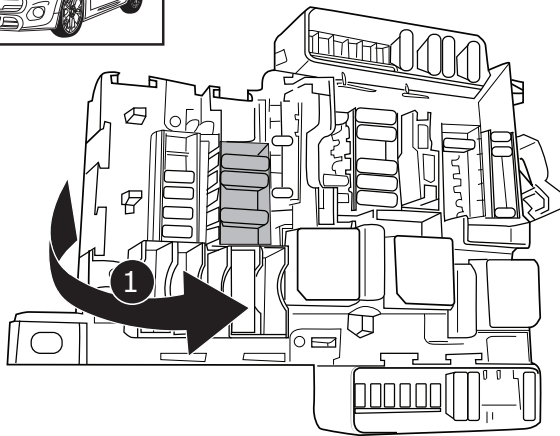

44

Disengage secondary lock

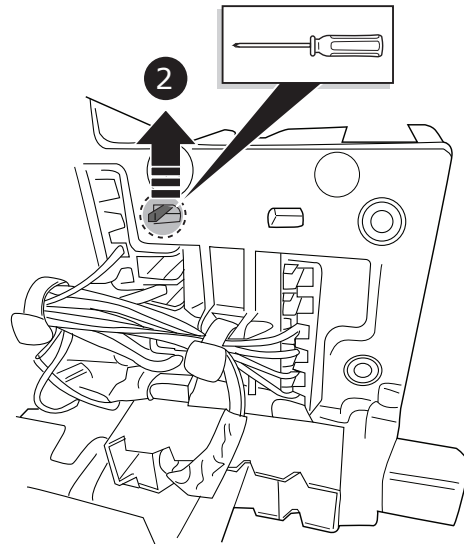

**Option 2**

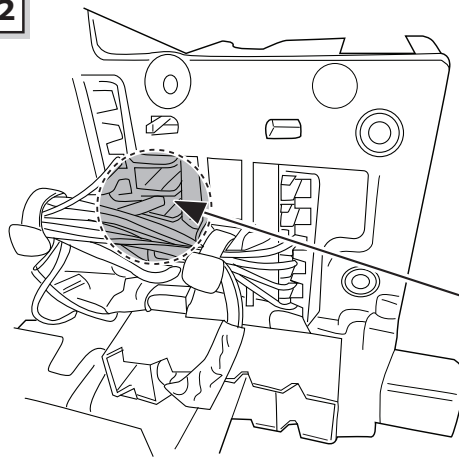

1

**Red/Blue**  
Choose a free space  
Chamber 43-48

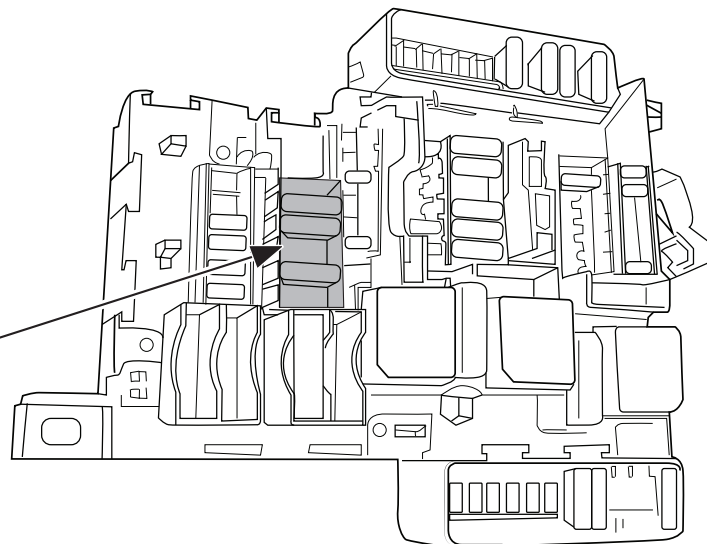
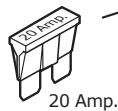
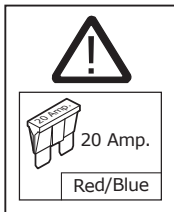
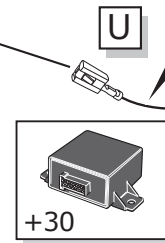

2

45





**Option 2**

**Optional chamber 9**

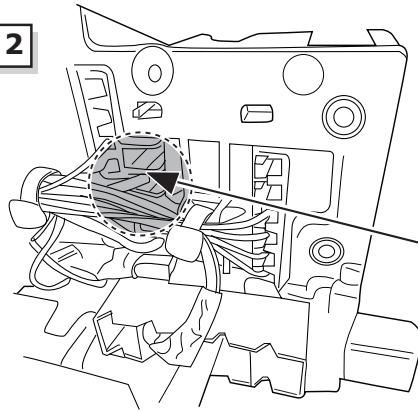

**Orange**  
Choose a free space  
Chamber 43-48

U

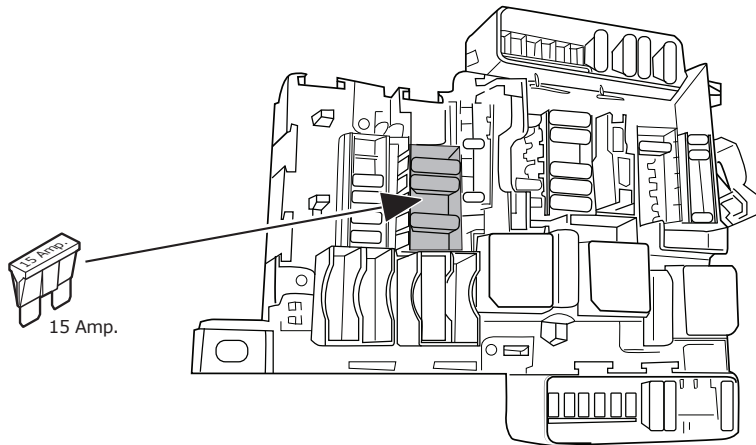
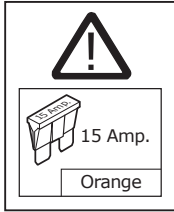
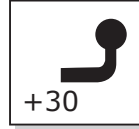

46



**Option 1 + 2**

**Optional chamber 10**

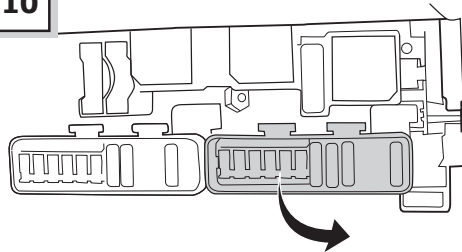

1

**Grey**  
Choose a free space  
Chamber 127-132

U



**Optional PIN 10**

2

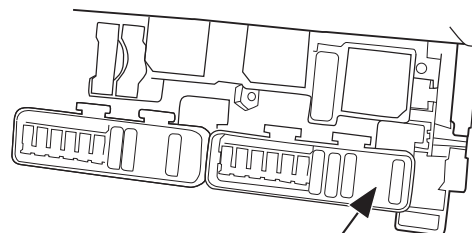
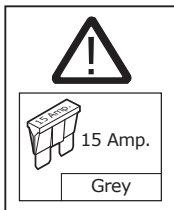
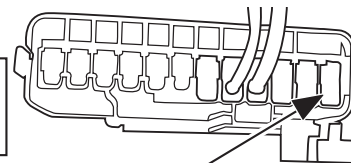

3

47

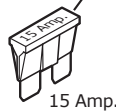

**Option 2**

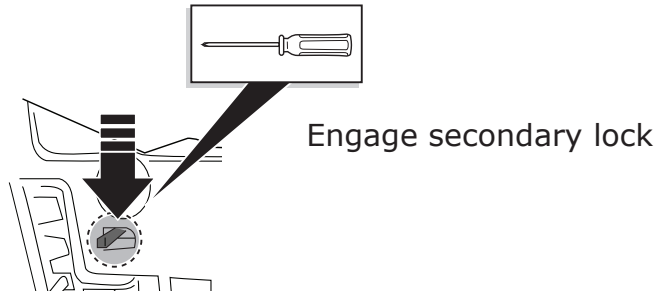

48



Please note the new fuse positions !!

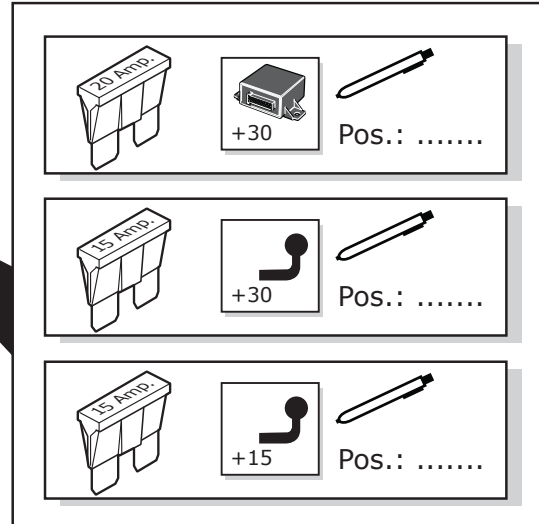
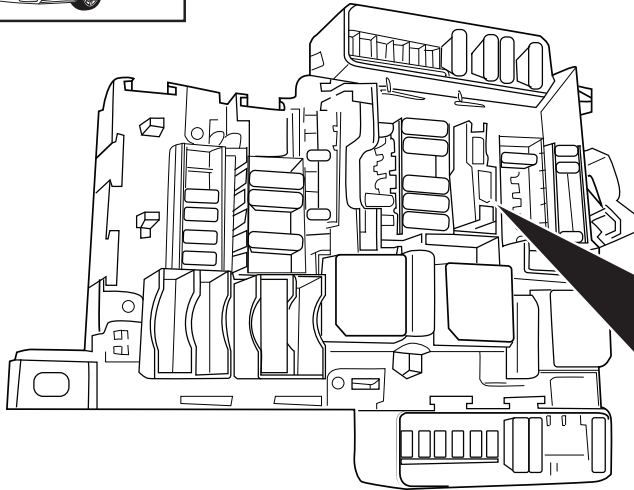

49

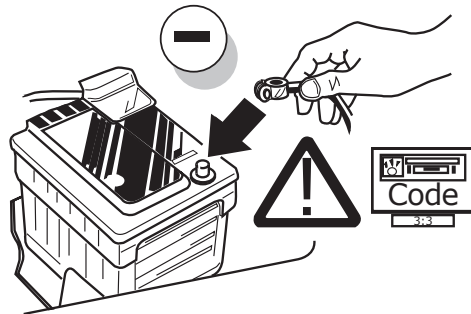

50

**Optional**

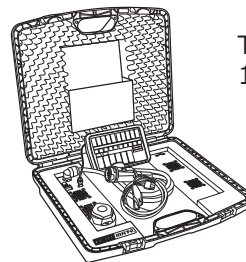

Trailer Simulator for 7- and 13-pin Sockets

51

**Functional test**

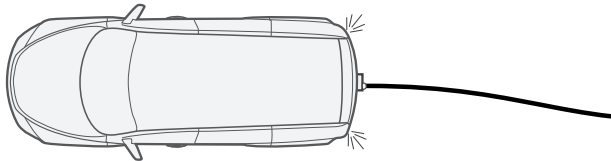
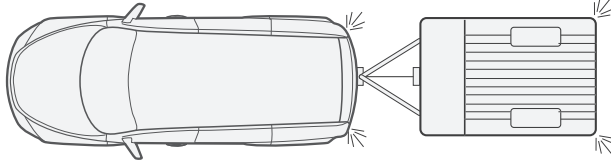
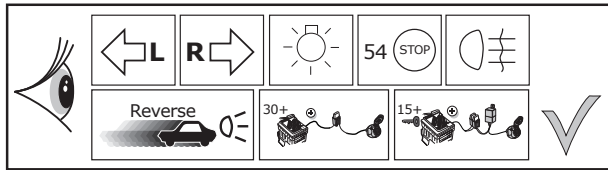

**WARNING**

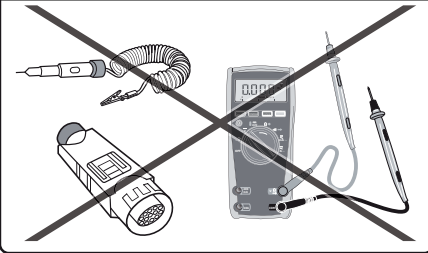

**LIGHT MATE**

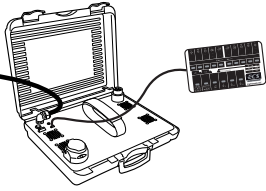

52

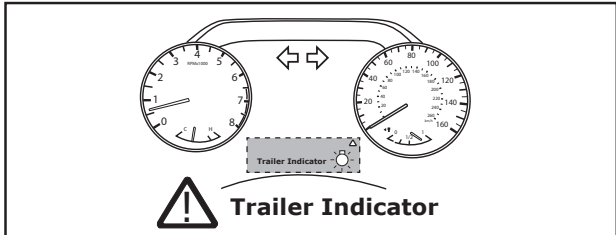
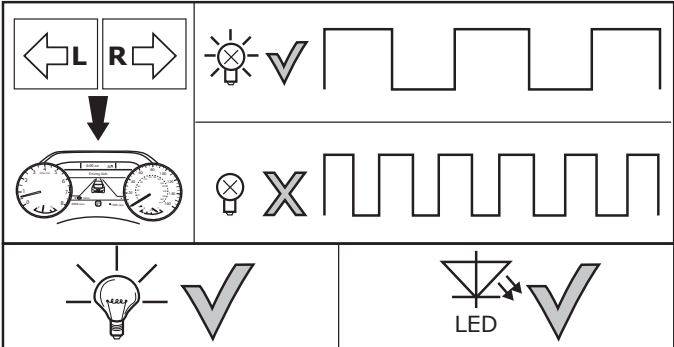
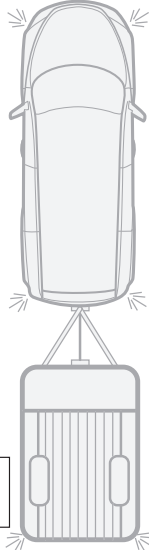

53

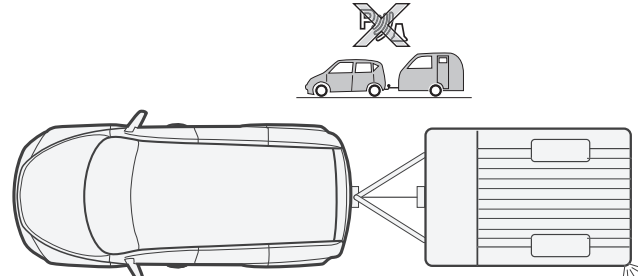
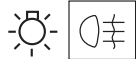
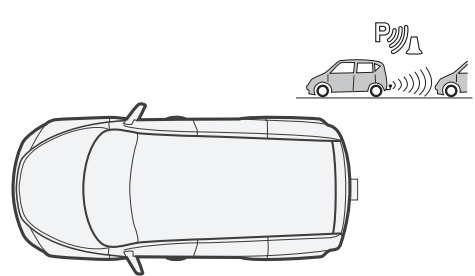
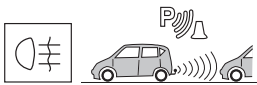

54

**Optional**

### Adapter socket

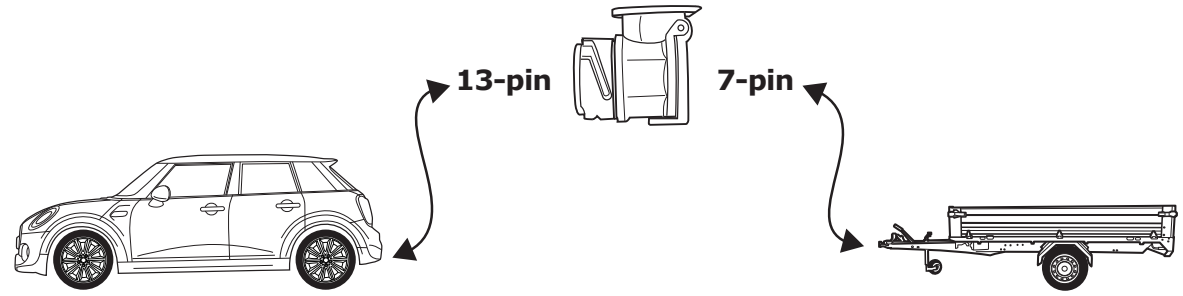

55

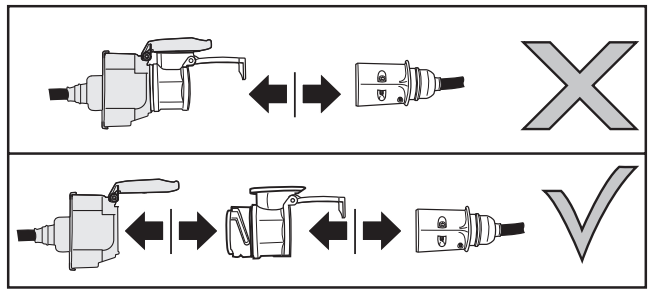
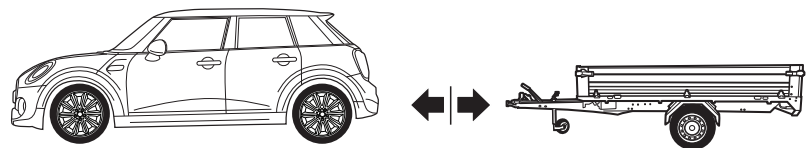

56

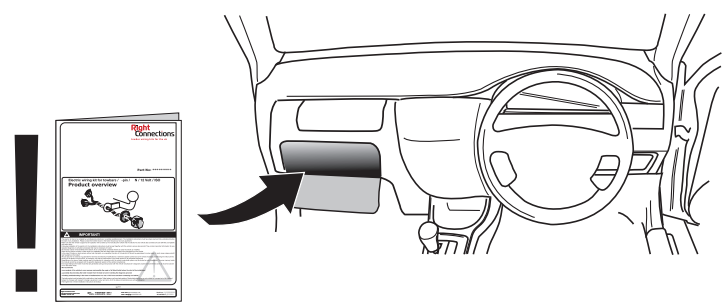

57